

TR
880
P323

H 16 Reflex

BOLEX

Instructions manual

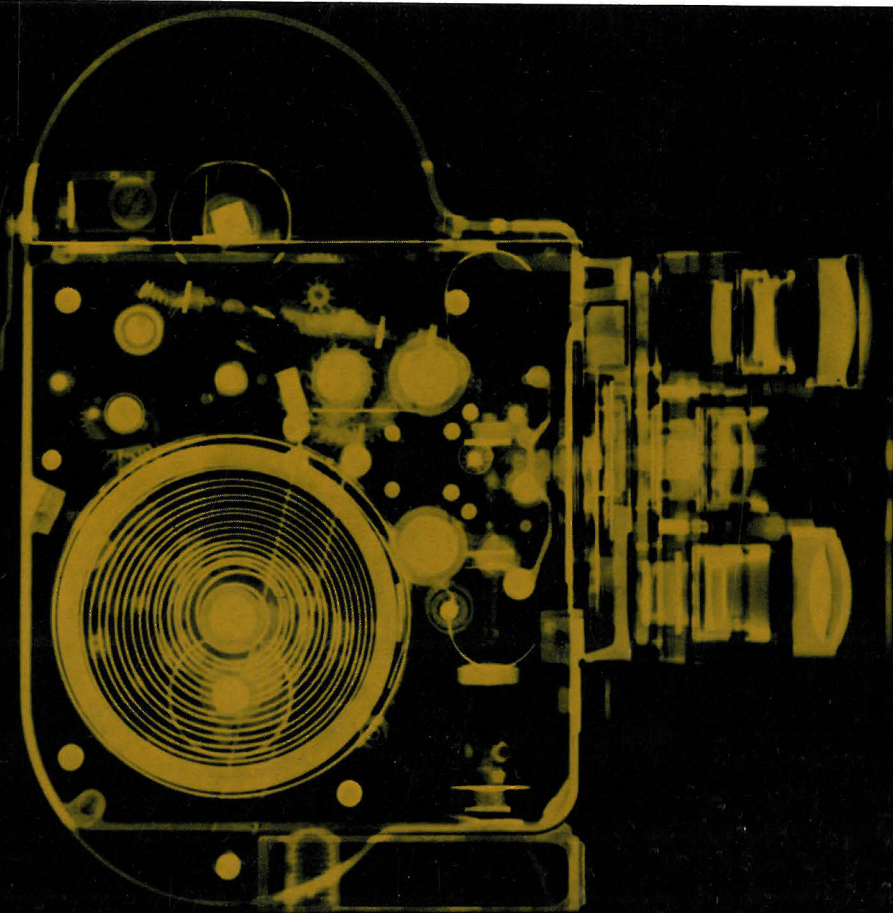

We strongly recommend that a test roll of film is exposed in the camera when first purchased. This will help you to get to know it and will ensure that the instructions given in this manual have been carried out correctly.

The camera is supplied with:

- 1 auxiliary multifocal viewfinder
- 1 filter holder on the camera
- 1 set of five filter holders
- 4 gelatine filters
- 1 rewind crank
- 1 folding rubber eyepiece
- 2 turret plugs
- 2 empty spools (100 ft. and 50 ft.)

212971

TR
880
P323

Throughout the world, Bolex cameras have acquired a reputation for unrivalled quality. The H 16 Reflex is the most advanced and comprehensive model in the Bolex range. It is appreciated not only by discerning amateurs and explorers but also by many professionals, scientists and those in the fields of industry and education. Its robust construction ensures excellent performance under all conditions.

With a world-wide network of agents, Paillard offers impeccable after-sales service in practically every part of the world. If service is required, return your camera to the Paillard-Bolex distributor in the country concerned. He is authorized to carry out repairs, adjustments and maintenance work. By so doing, you will benefit from the guarantee. In any correspondence, please remember to quote the serial number engraved on the base of your camera.

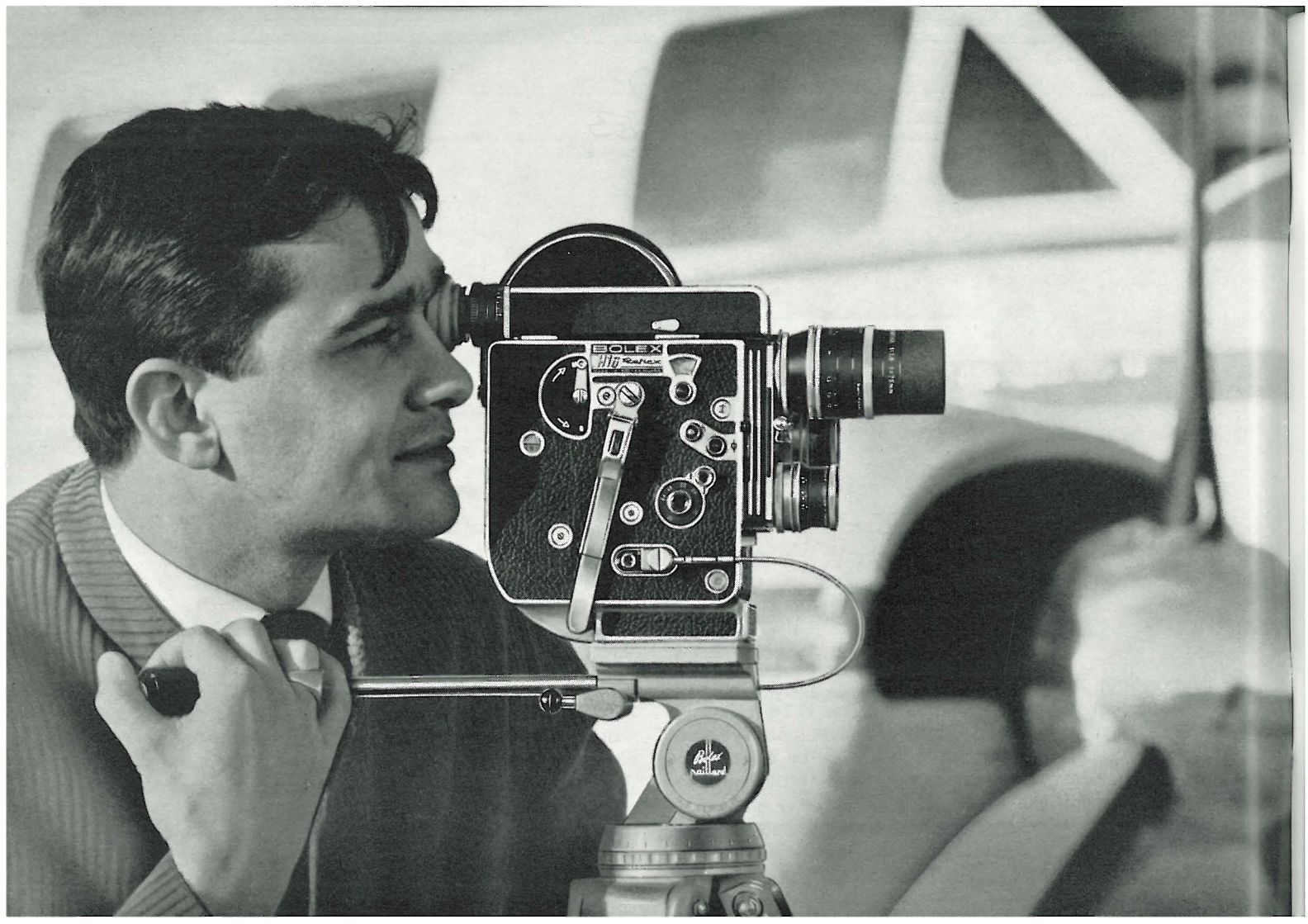

Contents

Get to know your camera

- 7 16 mm films
- 8 The reflex viewfinder
- 9 The auxiliary multifocal viewfinder
- 11 Optical equipment
- 11 The turret
- 11 The lenses
- 12 Distance setting
- 13 Diaphragm adjustment
- 14 The filters

Camera operation

- 16 Winding
- 16 Filming speeds
- 17 The release selector
- 18 Electric motor drive
- 19 Hand cranking
- 20 The variable shutter
- 21 Lap dissolves
- 23 Double exposures

Camera loading

- 27 Inserting the film
- 29 The footage counter
- 29 The frame counter
- 30 The audible signal

Unloading the camera

- 31 When the film is fully exposed
- 32 When the film is only partly exposed

Practical advice

- 33 Camera stability
- 34 Film composition
- 35 Panning shots
- 35 Lighting
- 36 Editing and titling films
- 36 Adding sound to films
- 37 Animation technique
- 38 Cartoons
- 39 Macro- and microcinematography
- 40 Faulty films and their causes
- 42 How to look after your camera
- 44 To complete your equipment

Get to know your camera

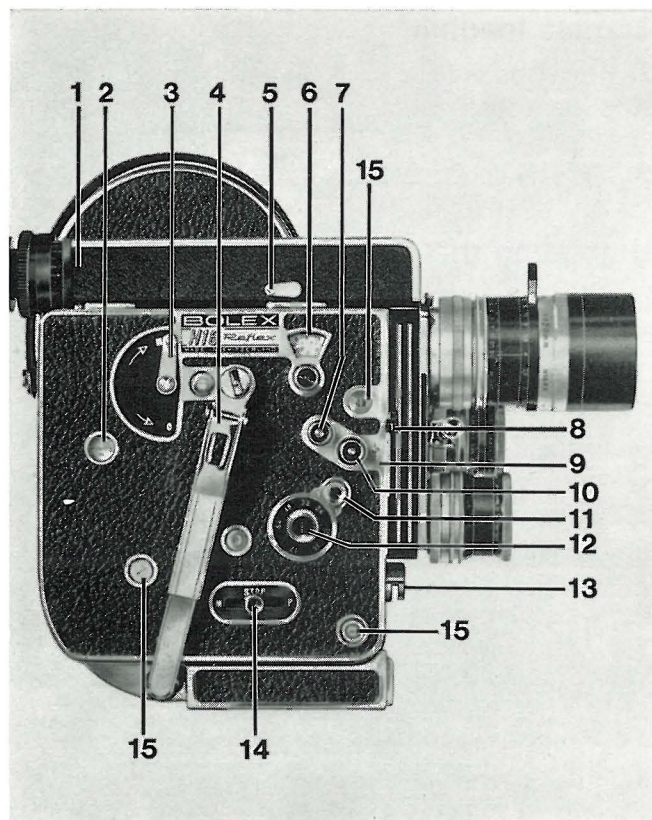

- 1 Reflex viewfinder (page 8)
- 2 Footage counter (page 29)
- 3 Lever for disengaging spring motor (page 16)
- 4 Spring motor winding handle—spring run: 28 sec. at 24 f.p.s. (page 16)
- 5 Reflex viewfinder closing lever (page 9)
- 6 Frame counter (page 29)
- 7 Coupling spindle for electric motor MCE 17 B and film rewind handle (pages 18 and 19)
- 8 Variable shutter dial and control lever (page 20)
- 9 Film plane guide mark
- 10 Coupling spindle for electric motor MST (page 18)
- 11 Exposure control knob for instantaneous (I) or time exposures (T) (single frame filming) (page 17)
- 12 Film speed selection knob (page 16)
- 13 Front release for normal running (page 17)
- 14 Side release for normal running, continuous filming (M) and single frame exposures (P). Can be operated by cable (page 17)
- 15 Threaded holes for various accessories and motors

- 16 Lever for suppressing audible signal (page 30)
- 17 Upper spool shaft for feed spool
- 18 Upper loop former
- 19 Upper sprocket
- 20 Pressure pad locking pin (page 27)
- 21 Loop former locking lever and opening knob (page 28)
- 22 Pressure pad (page 27)
- 23 Lower sprocket
- 24 Lower loop former
- 25 Lower spool shaft for take-up spool
- 26 Film knife
- 27 Spool ejector (page 31)
- 28 Retaining arm
- 29 Feet setting on footage counter (page 29)

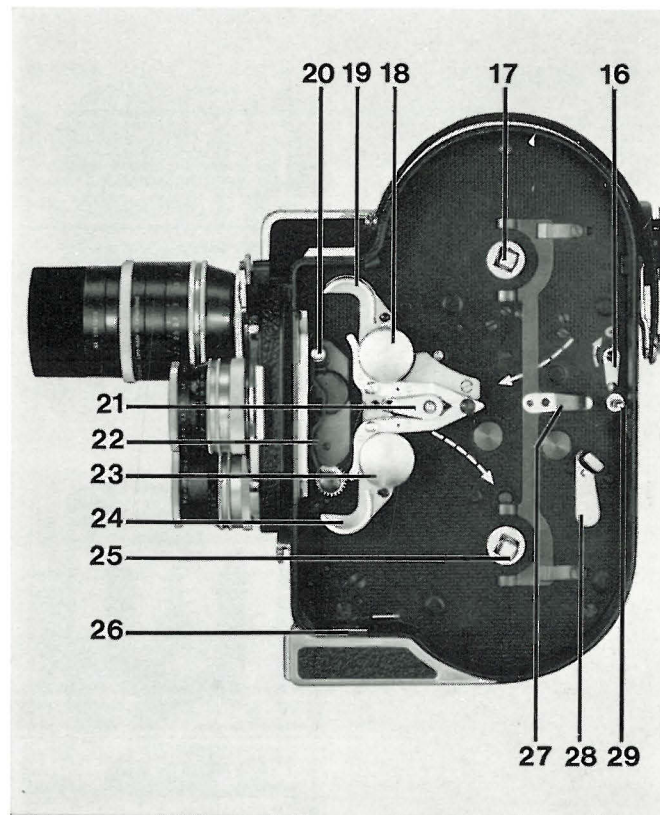

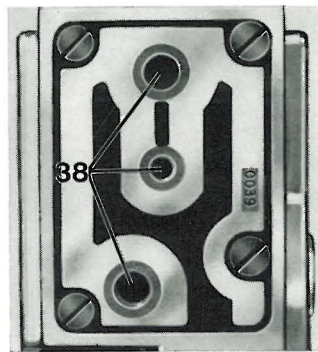
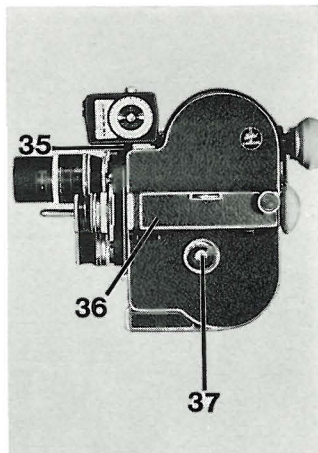
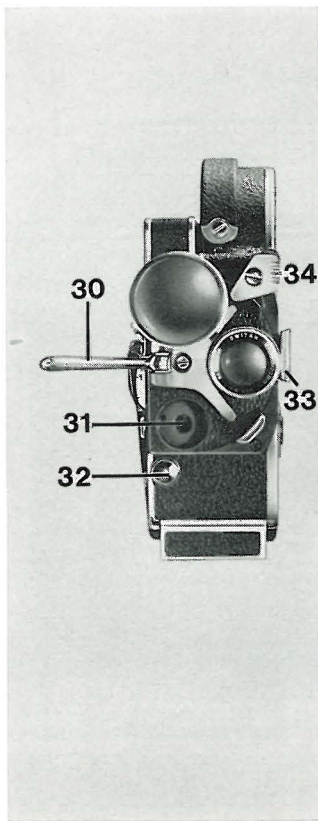

- 30 Turret lever (page 11)
- 31 Threaded hole for turret locking screw
- 32 Front release for normal running (page 17)
- 33 Filter holder (page 14)
- 34 Turret locking clamp (page 11)
- 35 Shoe for attaching exposure meter (page 13)
- 36 Auxiliary multifocal viewfinder (page 9)
- 37 Lid opening ring
- 38 Three threaded holes (2— $\frac{3}{8}$ " dia and 1— $\frac{1}{4}$ " dia) for tripod or hand grip
- 39 Serial number of the camera (page 1)

16 mm films

The H 16 Reflex camera takes 100 or 50 ft. spools of single or double perforated 16 mm film. Films with a single row of perforations are used when a magnetic track is to be added to the original film.

At each extremity of the film there is a leader—approximately 6 ft. at the beginning and 3 ft. at the end—to prevent the sensitive film being exposed to light during loading or unloading. These leaders are usually removed by the processing laboratories.

Black-and-white and colour films come in various sensitivities, which are expressed in ASA or DIN degrees and indicated on the instructions leaflet accompanying each film. The date before which the film should be exposed is normally stamped on the film pack. 16 mm film is available in the unprocessed condition with a magnetic stripe for sound recording. We would advise you against using this film: the magnetic layer can cause premature wear on the parts which come into contact with it, particularly the pressure pad, and metal particles may find their way into the camera mechanism.

Film running times at the following filming speeds

f.p.s.	12	18	24	32	48	64
1 m (≈ 3 ft)	10.9 sec.	7.3 sec.	5.5 sec.	4.1 sec.	2.7 sec.	2 sec.
15 m (≈ 50 ft)	2 min. 44 sec.	1 min. 49 sec.	1 min. 22 sec.	1 min. 1 sec.	41 sec.	30 sec.
30 m (≈ 100 ft)	5 min. 28 sec.	3 min. 38 sec.	2 min. 44 sec.	2 min. 3 sec.	1 min. 22 sec.	1 min. 1 sec.

The reflex viewfinder

The optical system of the H 16 Reflex camera allows for through-the-lens viewing during filming as well as when the camera is not running. The picture formed on the ground glass of the reflex prism is absolutely free from flicker.

The reflex viewfinder enables framing and accurate

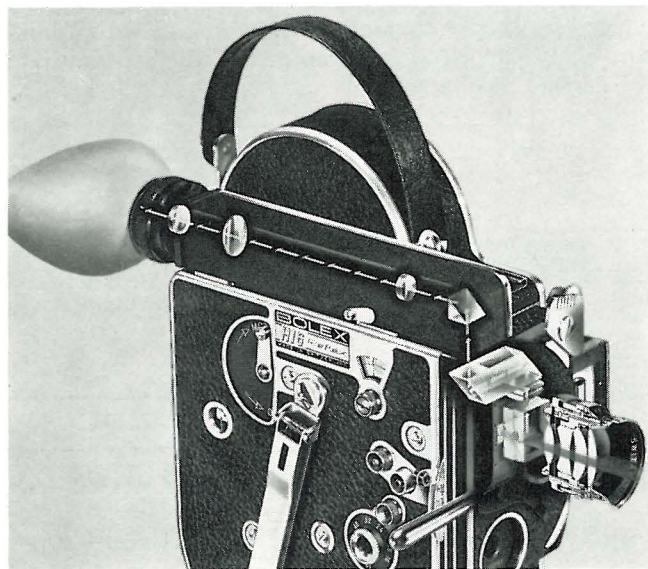

focusing of the subject to be achieved. In addition, it enables you to estimate the depth-of-field, to determine the correct focal length, to check on the filter being used and to evaluate the illumination of the scene.

The reflex prism deflects, into the viewfinder, an average of 20-25% of the light passing through the lens. This factor has been taken into account in the table of exposure times on page 13.

Adjusting the viewfinder eyepiece to the operator's eyesight. This adjustment adapts the viewfinder to the operator's eyesight, whether or not he wears spectacles, and remains the same for all lenses used on the camera. It is advisable to check this adjustment from time to time.

1. Turn the turret to expose the reflex prism.
2. View a well-lighted subject.
3. Loosen the milled ring (b) and turn lever (c) until the grain of the ground glass is perfectly sharp. Then tighten the ring (b) which acts as a lock-nut.

If your eyesight is normal, the line engraved on the lever (c) will be opposite the longest line on the fixed ring.

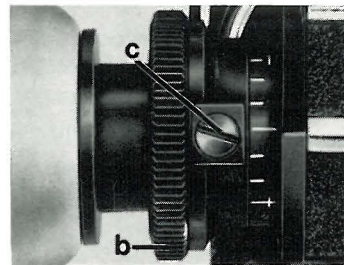

Closing the viewfinder. If the reflex viewfinder is not used during filming, close it by moving the small lever (a) into a vertical position. If it is left open, there is a risk of sunlight or artificial light from behind the camera entering the viewfinder eyepiece and fogging the film.

Focusing. Open the diaphragm wide, then turn the distance setting ring until the picture is in sharp focus on the ground glass. Then close the diaphragm to the correct setting.



The auxiliary multifocal viewfinder

The H 16 Reflex camera is equipped with a detachable multifocal viewfinder, provided with parallax correction from 20" to infinity. Its field can be instantly and continuously adapted for lenses with focal lengths of 16, 25, 35, 50, 63, 75, 100 or 150 mm. The viewfinder also incorporates an extra lens, mounted on a sliding bracket. Quickly put into place, this lens immediately adapts the viewfinder to the field of a wide-angle lens (10 mm). When this lens is in use, the multifocal viewfinder should be set for the shortest focal length (16 mm).

The auxiliary viewfinder can be mounted or removed from the camera in seconds by means of a lever. It is extremely useful for previewing the subject, and therefore picture composition and focal length can be determined without having to move the camera.



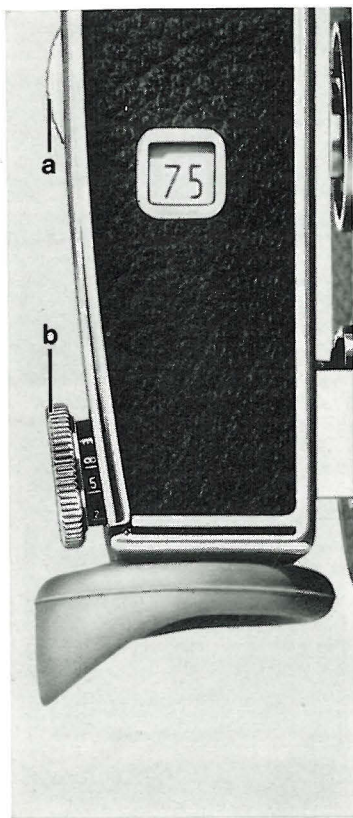

Adjustment of the viewfinder field. The viewfinder field is adjusted by rotating the disc (a). The focal lengths are visible in the upper window and also appear in luminous figures in the viewfinder itself, thus permitting a permanent check on the focal length in use. The indicators in the finder window facilitate horizontal and vertical centering of the subject.

Parallax correction. The viewfinder is so positioned on the camera as to eliminate any vertical parallax. To correct lateral parallax, turn the scaled knob (b) until the number corresponding to the filming distance faces the guide mark. This distance is calculated from the film plane. Set the sign ∞ opposite the guide mark at the end of filming. To accurately frame subjects at less than 1 ½ ft., the reflex viewfinder should be used.

Adjusting the viewfinder to the operator's sight. Corrective lenses of different dioptric power are available, on request, to adapt the viewfinder to the eyesight of spectacle wearers. The Paillard-Bolex distributor for your country will fit a corrective lens to the viewfinder if you let him know the lens power required.

Optical equipment

The turret. Simply by turning the turret, you can change rapidly from one focal length to another, from a medium long view to a long view or a close-up. To turn the turret, use its fold-away lever. In this way, there is no risk of accidentally moving the diaphragm and focusing rings. Three click stops ensure that the lenses are correctly positioned in front of the filming aperture. When using heavy lenses, such as zooms or telephotos with very long focal lengths, the turret should be locked (Pos. 2) with a special clamp.

Correct position of the lenses on the turret. Keep the lenses positioned as shown opposite, so that there is a reasonable distance between the wide-angle lens (1) and the long focal length lens (3). It is as well to remove 100 and 150 mm lenses from the turret before using a shorter focal length lens, in order to keep its field clear. When using a heavy lens, such as a zoom, the turret should be locked with a plug.

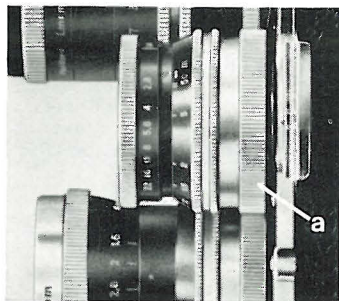
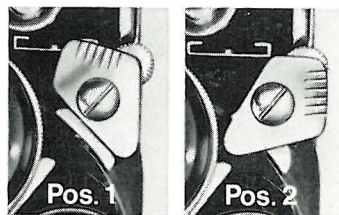
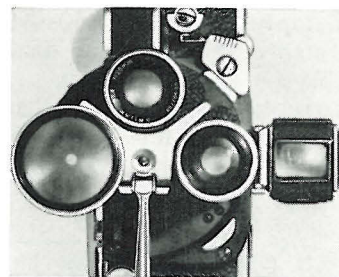
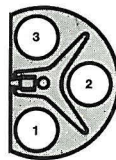

The lenses. The H 16 Reflex camera takes "C" mount lenses (see important note below) which have the following characteristics:

Thread diameter: 25.4 mm (1")

Maximum thread length: 4.06 mm (.160")

Film plane / lens seat distance: 17.52 mm (.690")

Lenses should be held by their rear rings (a) when being screwed into the turret.

Standard lenses (25 and 26 mm) are suitable for most shots.

Wide-angle lenses (10 and 16 mm) are used for general views or when it is difficult to move back from the subject (buildings, interiors, etc.). They give heightened perspective.

Telephoto lenses (50—150 mm) are used for long distance shots and are ideal for filming sports scenes, children, animals, etc.

To protect lenses from dust and impurities, it is advisable to replace the lens caps between takes.

Important. Special 10, 16, 25 and 50 mm lenses have been designed exclusively for use on the H 16 Reflex camera. Lenses with focal lengths over 50 mm can generally be used equally well on the H 16 Reflex as on cameras without reflex viewfinder.



Focusing

The reflex viewfinder of the H 16 Reflex camera shows you the picture as it will appear on the film, with its sharp and blurred areas faithfully reproduced. It is thus simple to focus accurately and, at the same time, to estimate the depth-of-field.

The depth-of-field is the area within which the picture is in focus. It varies according to the focal length of the lens, the diaphragm opening and the filming distance. The longer the focal length, the wider the diaphragm opening or the shorter the filming distance, the shallower the depth-of-field will be. Focusing must therefore be especially accurate.

Conversely, the shorter the focal length, the smaller the diaphragm opening or the longer the filming distance, the wider the depth-of-field will be—and the greater the margin for focusing inaccuracy.

On most lenses, a depth-of-field scale indicates the distances within which the picture will be in focus. Lenses are also supplied with a depth-of-field chart. Distances are calculated from the film plane, marked ϕ .

Diaphragm setting

The lens diaphragm controls the amount of light reaching the film and is adjusted according to the lighting conditions, the film sensitivity, the filming speed and the position of the variable shutter. The amount of light admitted by the diaphragm is doubled at each successive setting, starting from the highest figure. For instance, moving the diaphragm setting from f/11 to f/8 doubles the amount of light passing through the lens.

The Bolex exposure meter was designed and calibrated especially for the H 16 Reflex camera and allows for the fact that 20-25 % of the light is deflected into the viewfinder by the reflex prism. The exposure meter fits on to a special shoe (see page 6).

The use of the exposure meter safeguards against exposure errors. In the chart opposite, the figures listed in the column under "adapted exposure times" take into account the light deflected by the reflex prism.

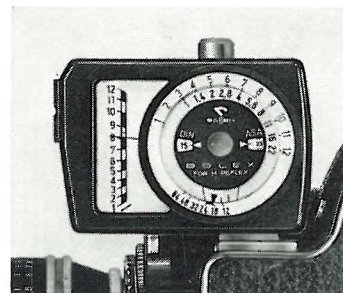

Exposure times (in fractions of a second)

Filming speed	Shutter open Lever up		Shutter ¼ closed Lever on ½		Shutter ½ closed Lever on 1	
	Real	Adapted	Real	Adapted	Real	Adapted
12 f.p.s.	1/33	1/40	1/45	1/55	1/75	1/94
16 f.p.s.	1/45	1/55	1/60	1/75	1/100	1/125
18 f.p.s.	1/50	1/60	1/70	1/87	1/110	1/137
24 f.p.s.	1/65	1/80	1/90	1/112	1/150	1/188
32 f.p.s.	1/90	1/110	1/120	1/150	1/200	1/225
48 f.p.s.	1/130	1/160	1/180	1/225	1/300	1/375
64 f.p.s.	1/180	1/220	1/240	1/300	1/400	1/500
Speed control knob on 18-64 f.p.s.	Single-frame exposure		(selector in position T)			
	1/30	1/40	—	—	—	—

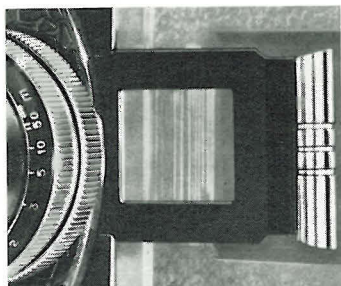

Filters

The H 16 Reflex camera has a filter-slot between the taking lens and the reflex prism. The filters therefore remain in place whichever lens is being used. **When filming without a filter, an empty filter holder should be left in the slot to prevent light infiltration which would fog the film. See that the filter mount is firmly located in the slot.**

The set of filters for the H 16 Reflex camera comprises four filter holders, a filter cutting frame and four envelopes, each containing one of the following 2" square gelatine filters.

The effect of a filter varies according to the type of film, its sensitivity and the lighting conditions. The diaphragm corrections below should be considered as only approximate.

The 1 A Skylight filter for colour films, tones down excessive blue and improves colour reproduction (in the shade or overcast weather, for distant shots, when filming in snow or at high altitudes). This filter requires no diaphragm correction.

The 85 Daylight filter for colour films is a conversion filter. It is used for filming in daylight with Kodachrome II Type A artificial light film. When setting the diaphragm, remember that colour film for artificial light, used with the 85 Daylight filter, has the same sensitivity as a daylight colour film used without filter.

The Yellow 8 filter is used for increasing contrast in black-and-white films.

Type	Open diaphragm	or divide ASA rating by
Kodak Wratten 1A Skylight	—	—
Kodak Wratten 85 Daylight	$\frac{2}{3}$ stop	1.6
Kodak Wratten 8 Yellow	1 stop	2
Kodak Wratten ND 06 Neutral density	2 stops	4

The neutral density filter can be used with both black-and-white and colour films and in no way affects colour reproduction. As the ASA sensitivity is reduced four times, the diaphragm can be opened two stops. This filter is used:

1. When the lighting conditions and the film sensitivity require an aperture lower than the smallest stop on the lens.
2. When it is desired to reduce the depth-of-field in order to achieve special effects (sharp foreground against blurred background).

Mounting gelatine filters. Filters are mounted as follows:

1. Hold the filter cutting frame horizontally (g).
 2. Insert gelatine filter, with its protective covers, as far as it will go into the frame.
 3. Hold the frame firmly and cut around it with sharp scissors.
 4. Remove the filter by its edges. Fingerprints cannot be removed.
 5. Remove the fastening clamp (a) from the filter mount.
 6. Open the spring blades (b) and (c).
 7. Insert the cut-out-filter (d) between the blades.
 8. Press the spring blades (b) and (c) together between thumb and index finger.
 9. Replace the fastening clamp (a).
- When you have finished, put the filter-mounts in their case to protect them from dust.

Focusing adjustment. Placing a filter behind the lens slightly alters the lens focusing. However, the necessary correction is automatically made when the reflex viewfinder is used.

Important. Because of its distance from the film plane, the filter mount cannot be used as a mask holder for trick effects, such as keyhole and binocular cut-outs. The shape of the mask will not appear on the film and it will only darken the scene.

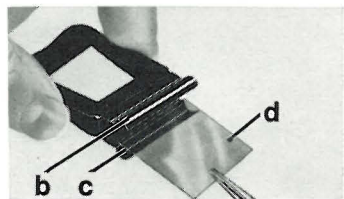
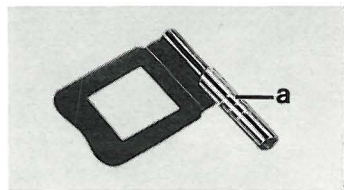
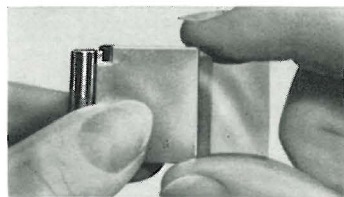
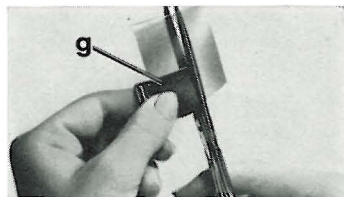

Camera operation

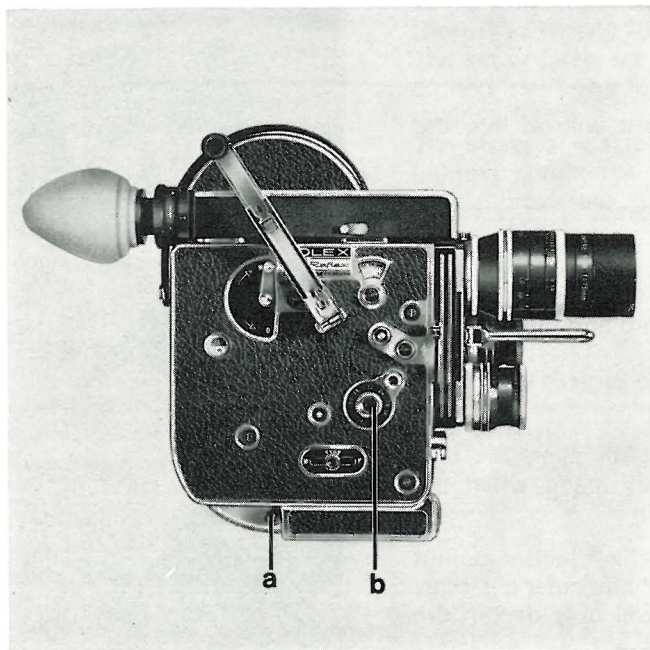

Winding the motor

Move the side release to STOP and the motor disengaging lever to MOT. Lift the motor winding handle, which automatically engages with the spindle, and turn anti-clockwise. Wind the spring motor fully but without forcing it, then lower the handle and secure it on catch (a). Otherwise, there is a risk of it turning with the motor during filming.

Fully wound, the motor drives nearly 18 ft. of film, i.e. 28 seconds' filming time at the speed of 24 f.p.s. Make a habit of rewinding the motor after each take, regardless of how much power is still in reserve.

Film speeds

The camera has seven filming speeds: 12, 16, 18, 24, 32, 48 and 64 frames per second.

To select the desired speed, turn the control knob (b) until the corresponding figure is opposite the red dot. When the film is projected at normal speed (18 or 24 f.p.s.), a lower filming speed will produce an accelerated motion effect while a higher filming speed will give a slow motion effect. When changing film speed, do not forget to alter the diaphragm setting. When changing from 24 to 32 f.p.s., the diaphragm should be opened half a stop, from 24 to 48 f.p.s. by a whole stop and from 24 to 64 f.p.s. by 1½ stops (see page 13).

Important. When the camera is not loaded, it should not be run at speeds over 32 f.p.s. as this could damage the mechanism.

The release selector

The H 16 Reflex camera can be used for normal, continuous or single-frame filming. These different operations are controlled by the **side release**.

Normal filming. This filming method is suitable for most general shots. The camera runs as long as the operator depresses the front release or pushes the side release towards M (generally by using a cable).

Cable release. For maximum stability, when the camera is mounted on a tripod, it is advisable to use a cable release which fixes, by means of an adapter, on to the side release knob.

Single frame filming. Push the side release to P.

Instantaneous: turn the knob until the guide mark is in position I. **Time exposures:** guide mark in position T (for use in poor lighting conditions, such as indoors).

When making time exposures, open the variable shutter fully or one of its blades may mask part of the picture.

You can also use an electric motor which ensures absolutely constant exposure time for every frame at the selected speed. This prevents the slight flicker which inevitably results from using a spring motor (see page 47).

Single frame filming is used for titles, cartoons, scientific films and various trick effects, particularly accelerated motion (clouds, sunsets, comic effects, etc.). Use a cable release to prevent any risk of camera movement.

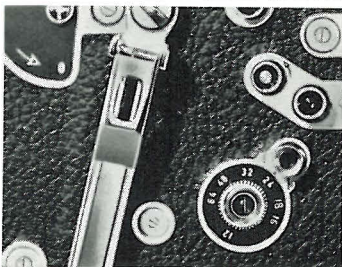
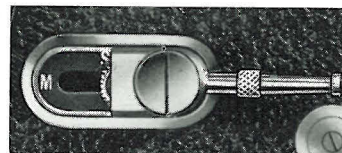



Continuous filming. Push the side release to M.

The camera will continue running as long as the motor is wound. To stop the camera, move the side release back to STOP.

Continuous filming with an electric motor. Long sequences can be filmed without interruption by using one of the following electric motors, which are easily fitted on to the camera.

The MCE 17 B motor drives the film at the chosen speed, from 12 to 32 f.p.s., by the coupling spindle (8 frames per revolution), battery driven.



The MST motor is a constant-speed motor which drives the film, at a specific rate, by the coupling spindle (1 frame per revolution). For filming with synchronized sound as well as for industrial and scientific work. Various models are available as follows:

- 24 f.p.s.: films for commercial use and American TV stations. Pilot generator, 50 or 60 ~ incorporated; automatic or remote-controlled clapstick.
- 25 f.p.s.: films for European TV stations. Pilot generator, 50 or 100 ~ incorporated; automatic or remote-controlled clapstick.
- $16\frac{2}{3}$ f.p.s.: for motion studies (1000 frames per minute).
- Motors operating at any other speed within 12 and 25 f.p.s. can be supplied to order.

The MST motor is powered by a portable cadmium-nickel battery with an incorporated rectifier which can be recharged from the mains, or powered from a 12 V accumulator, such as a car battery.



Hand cranking. The mechanism of the H 16 Reflex camera can operate in reverse as well as forward motion by means of a small auxiliary crank. The spool can thus be fully rewound and a partly exposed film removed from the camera. This is particularly useful for special effects, such as lap dissolves, double exposures and trick effects.

To rewind the film:

1. Disengage the motor by moving lever (1) to O. If you feel a slight resistance towards the end, do not force the lever but press the front release while continuing to move the lever.
2. Move the side release (2) to M (continuous filming).
3. **Close the variable shutter** by lowering lever (3) so as not to fog the film (see page 20).
4. Turn the hand crank (4) in the direction of the engraved arrow but do not try to rewind the film faster than allowed by the speed governor.

To resume normal motor-driven operation, move the side release to STOP and the disengaging lever to MOT.

Do not forget to re-open the variable shutter.

Important. The reverse system is designed for rewinding only and should not be used for filming.

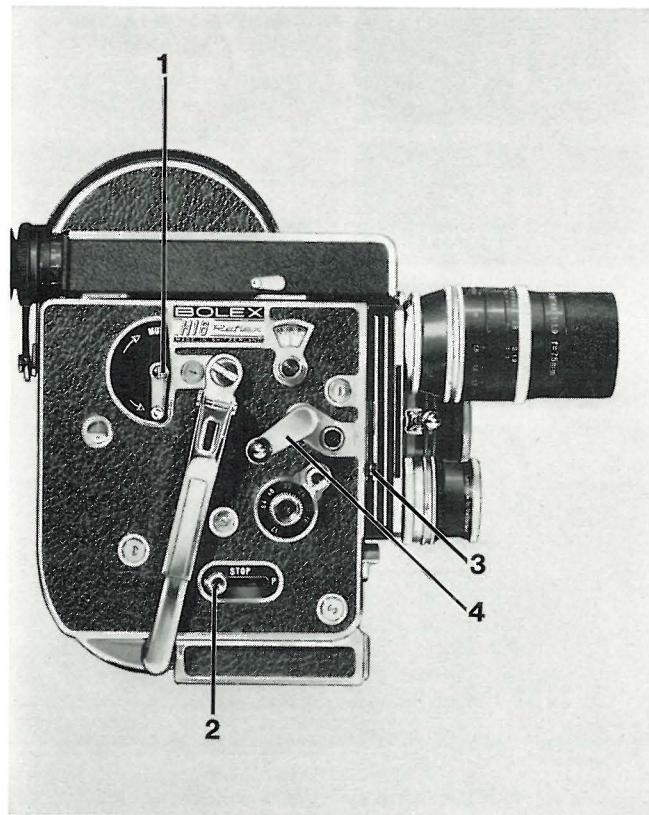

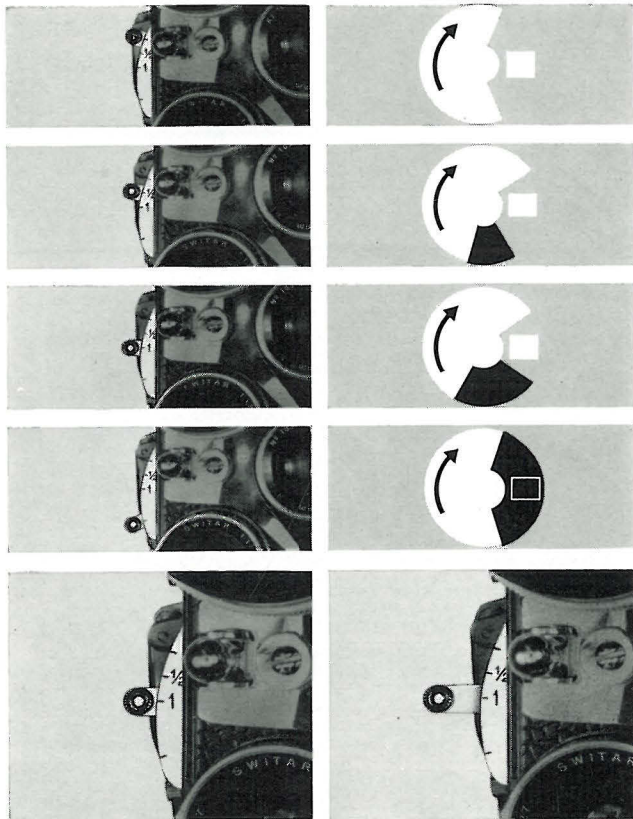

The variable shutter

The H 16 Reflex camera is equipped with a shutter whose aperture can be varied both when the camera is running and when it is stopped. This enables you to reduce exposure time without changing the filming speed. In dazzling light, such as snow and water scenes, the variable shutter can be used to reduce exposure, thereby often eliminating the need for a neutral density filter.

The shutter can be locked in each of its four positions by pushing the lever inwards. The $\frac{1}{4}$ and $\frac{1}{2}$ closed positions are marked on the face of the lever by the figures $\frac{1}{2}$ and 1, which signify:

$\frac{1}{4}$ closed position (marked $\frac{1}{2}$): the diaphragm should be opened half a stop to compensate for the reduced exposure time, due to the shutter being $\frac{1}{4}$ closed.

$\frac{1}{2}$ closed position (marked 1): the diaphragm should be opened one stop.

A triangular warning signal appears in the reflex viewfinder when the variable shutter is not in the fully open position.



Use of the variable shutter. The variable shutter enables you to achieve various effects, without the need for any other accessories. Some are described below.

Dissolves

Fade-in. A film beginning abruptly with a title or a brilliantly lit scene may dazzle the eyes of an audience in a darkened room. The eye needs only between $\frac{1}{2}$ second and 2 seconds to become adapted to the brightest screen image, if the transition is gradual. In such cases, it is a good idea to introduce the opening scene with a fade-in, using the variable shutter, as follows:

1. Close the variable shutter without locking the control lever.
2. Start the camera with the left hand while simultaneously opening the shutter with the right, using the lever. To ensure a smooth movement, press the middle finger against the edge of the turret and, holding the small black lever knob firmly between thumb and index finger, move the lever gently forward (see picture opposite).

Before beginning to film, practice making this movement smoothly and, particularly, making it last the desired time. Duration can be checked by repeating aloud a previously timed phrase. Alternatively, you can use the audible signal (see page 30).

3. Continue filming until the end of the first sequence.
4. For safety's sake, lock the lever in the "open" position before filming further sequences.

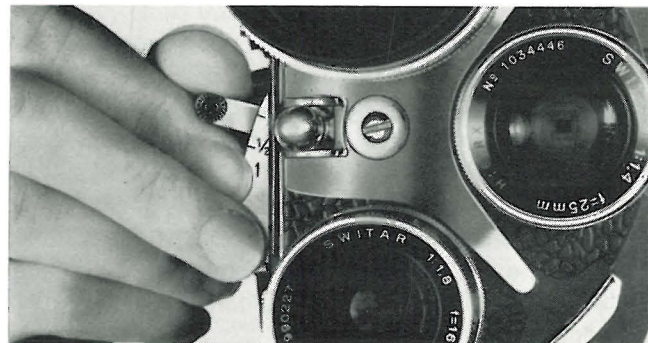

Fade-out. A gradual darkening at the end of the last scene avoids an abrupt finish. The fade-out can be slower than the fade-in and is achieved in the same way, only in reverse order.

Transitional fade. If you cannot avoid linking two scenes with an appreciable difference in light, the transition will be smoother if you end the first scene with a fade-out and begin the second with a fade-in. To avoid a break in continuity, these two fades should not last longer than two or three seconds.

Lap dissolve. A lap dissolve is unquestionably one of the most pleasing ways of linking two sequences. It is made by superimposing a fade-in on a fade-out so that one picture gradually disappears as the next gradually appears. This makes for a very smooth transition during which the picture brightness scarcely varies.

To produce a lap dissolve:

1. Close the sequence with a fade-out, without interrupting filming and without regard to the frame counter.
2. Lock the shutter in the "closed" position.
3. Set the two dials of the frame counter to zero.
4. Disengage the motor and rewind the film in reverse until the frame counter indicates the figures corresponding to the duration of the fade-out. An example is shown on the table opposite (page 23).
5. Move the side release to STOP and the lever to MOT.
6. Frame the second sequence and release the shutter lever.
7. Press the release and simultaneously make a fade-in of the same length as the previous fade-out.

N. B. Producing these fades is greatly facilitated by using the variable shutter automatic control, the REX-FADER (see page 45).

Duration of fade in seconds	Filming speed	
	18 f.p.s.	24 f.p.s.
1½	973	964
2	964	952
2½	955	940
3	946	928

Double exposures

In order to enhance the artistic effect of a sequence, the professional cameraman sometimes uses double exposures, i.e. the superimposing of two different scenes filmed on the same length of film.

a) To double expose the whole sequence:

1. Set the lens diaphragm according to the lightmeter reading.
2. Half close the variable shutter by locking the lever in position "1".
3. Set the frame counter to zero.
4. Film the first scene.
5. Note the reading of the frame counter.
6. Fully close the variable shutter and lock the lever in that position.
7. Disengage the motor and wind the film back until the frame counter again reads zero.
8. Engage the motor.
9. Free the variable shutter lever and lock it in position "1".
10. Film the second sequence until the frame counter reaches the figure noted under point 5.
11. Open the variable shutter and lock its lever in that position.

b) **To double expose only part of the sequence:**

1. Set the lens diaphragm according to the lightmeter reading.
2. Film the beginning of the scene, stopping when you reach the point where you intend to introduce the double exposure.
3. Set the frame counter to zero and free the variable shutter lever.
4. Continue filming. Start with a semi fade-out of about $1\frac{1}{2}$ seconds, by lowering the lever to position "1". Lock the lever in that position without stopping filming.
5. Stop filming where you want the double exposure to end and note the frame counter reading.
6. Free the variable shutter lever.
7. Continue the sequence with a semi fade-in of about $1\frac{1}{2}$ seconds and end it with the lever locked in the "open" position. Note the frame counter reading.
8. Fully close the variable shutter and lock the lever in that position.
9. Disengage the motor and wind the film back until the frame counter reads zero.
10. Engage the motor and free the variable shutter lever.
11. Film the superimposed scene, beginning with a semi fade-in of about $1\frac{1}{2}$ seconds, by moving the lever to position "1" and locking it without stopping filming.
12. Stop filming when the frame counter reaches the number noted under point 7.

Choosing a more favourable diaphragm opening.

As a rule, very small diaphragm apertures should be avoided, as there is a risk of diffraction affecting picture quality. Moreover, with some film sensitivities and lighting conditions, even the smallest diaphragm opening cannot prevent over-exposure. As the variable shutter permits reduced exposure time without changing the filming speed, both these risks are greatly minimized and a neutral density filter is unnecessary.

Increased picture definition. Closing the variable shutter reduces exposure time and thereby increases the sharpness of moving subjects. However, if the filming speed is not increased, this procedure can result in jerkiness on the screen.

In special cases, where picture sharpness is more important than steadiness (such as frame-by-frame analysis of scientific phenomena, sports contests and motion studies), it is an advantage to be able to reduce exposure time, without changing filming speed, as this diminishes the blur caused by a moving subject. Increased picture sharpness is especially useful for projection on wide screens. To safeguard against the risk of jerkiness, due to the shutter being partially closed, the filming speed should be increased—for instance, to 24 f.p.s. or over when filming with the shutter half closed.

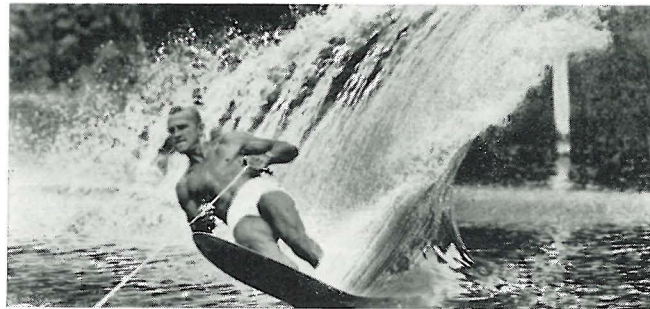

Loading the camera

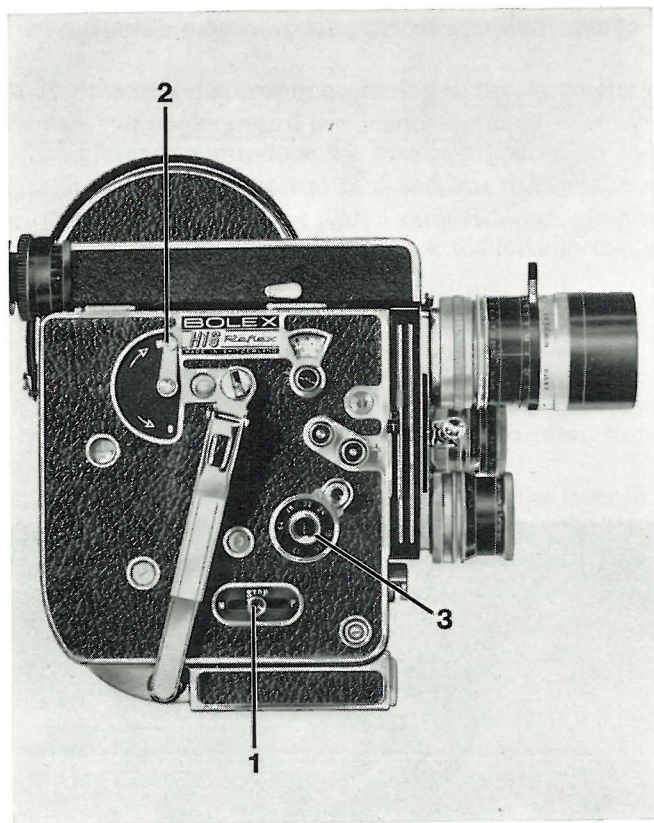

Now that you are familiar with the various features of your camera and know how they are operated, you are ready to start loading.

To avoid exposing the edges of the film to light, the camera should be loaded in a dimly lit place, well away from sunshine.

Before loading the camera:

1. Set the side release (1) to STOP.
2. Set the disengaging lever (2) to MOT.
3. Move the selection knob (3) until the number corresponding to the desired filming speed faces the red dot.
4. Wind the camera (page 16).

Inserting the film

Lift the lid opening ring, turn it in the direction marked by the arrow O, then lift off the lid. The inside of the camera is as shown in the illustration.



Prepare to load the film as follows:

1. Check that the pressure pad pin (a) is locked and that the pressure pad cannot open.
2. Remove the empty spool from its spindle by pressing ejector (b) and place the spool holding the film on the upper spool shaft (film should run in the direction indicated by the engraved arrow).

In the film gate, the dark, shiny side of the film (the backing) should face towards the back of the camera and the light matt side (sensitized) towards the lens.

3. Using the film knife, cut off the end of the film diagonally between two perforations, as shown in the illustration. Remember to remove the piece which has been cut off.
4. Close the loop formers by moving the control lever parallel to the pressure pad.

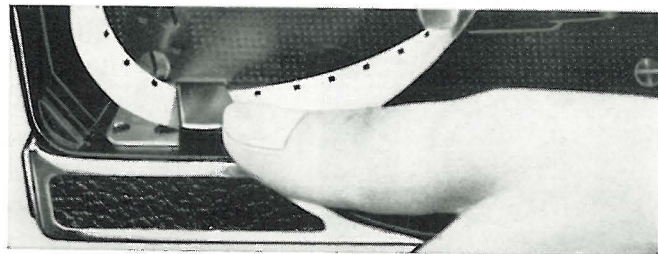
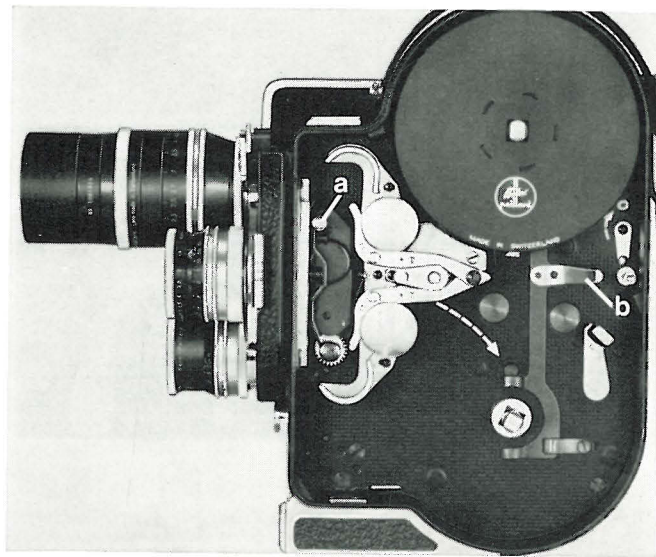

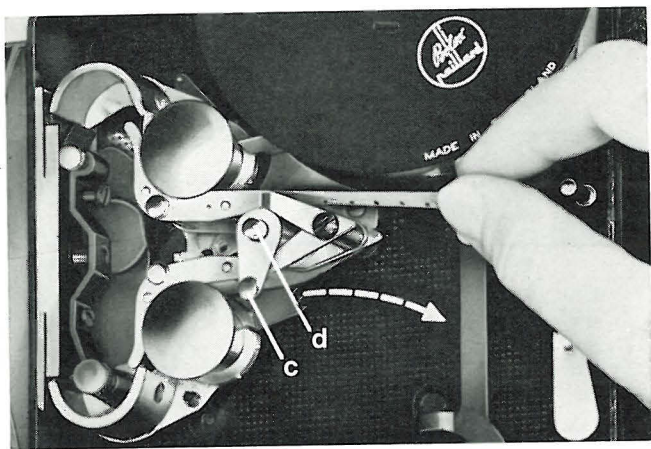

5. Press the release while simultaneously pushing the end of the film against the sprocket (illustration opposite). **The film is automatically threaded into the camera.**
6. Continue to depress the release until 10 to 12" of film have passed through the drive mechanism.
7. Open the loop formers by pressing knob (d). (If you accidentally leave them closed, they will automatically open when the camera lid is replaced.)
8. Insert the end of the film into the slot in the core of the take-up spool. Rotate until about three turns of film have been taken up and place the spool on the lower spool shaft.
9. Turn the take-up spool by hand, clockwise, to take up any slack film.

Final check. Press the release and run the camera for several seconds to ensure that the film advancing normally and the loops at either end of the film gate are forming correctly.

Replace the lid and lock it by turning the ring in the direction indicated by the arrow F. If it does not lock, do not force the ring! The spools or the pressure pad may be incorrectly positioned.

Finally, press the release until the film leader has been taken up. The camera is now ready for use (see following pages).

The footage counter

The footage counter shows the length of film that has been exposed. Once the camera is loaded, this counter reads **ft.** Run the camera until the figure 0 arrives opposite the white line in the centre of the red mask. This indicates that the film leader has been taken up and you can start filming. The counter automatically returns to **ft.** when the camera lid is removed for loading or unloading film. The footage counter is sufficiently accurate for ordinary filming. For special effects that require absolute precision, the frame counter should be used.



The frame counter

By indicating the exact number of frames exposed, this counter is invaluable for scientific studies, as well as various effects, such as lap dissolves and double exposures. It is also very useful for single frame filming (animation technique, see page 37).

The upper dial adds the frames in forward run and subtracts them in reverse run, from 0–50 frames.

The lower dial totalizes, in units of 50, the frames in forward run and subtracts them in reverse run, up to 1000 frames.

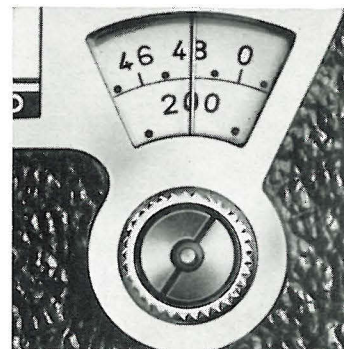

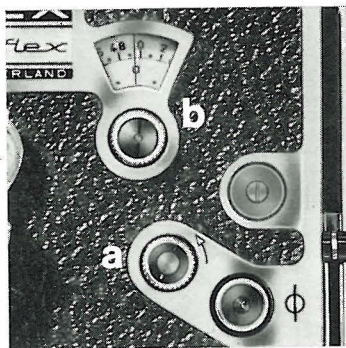

Beyond this figure, the cycle starts again and the figures shown on both dials should be added to the 1000 frames already totalized. Take no notice of the relative positions of the dials but only of their readings.

You can easily check if the figures shown on the frame counter refer to the first or second cycle, by looking at the footage counter. 1000 frames of 16 mm film correspond to 25 ft.

To set the frame counter to zero, use knob (a) which controls the upper dial and knob (b) which controls the lower "totalizer" dial.

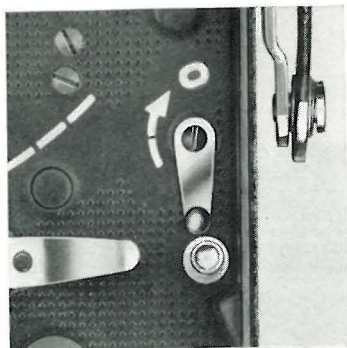

Audible signal

A clicking sound marks the passage of each 8" of film and is heard approximately every second at the speed of 24 f.p.s., every 1½ seconds at 18 f.p.s. The length of a scene can thus easily be estimated while filming. To reduce the strength of the audible signal, or to eliminate it altogether, move the small lever inside the camera, next to the counter pin, towards zero.

Unloading the camera

After the film is fully exposed

When the footage counter shows that the film is entirely exposed, run the camera for about 10 seconds to wind the end leader on to the take-up spool. Before opening the camera, make sure there is no film left in the gate, as follows:

Move the exposure knob guide mark to position T and turn the turret to reveal the aperture. Then push the side release to P to open the shutter. If any film remains, it will be seen, as an ivory coloured rectangle, in the aperture. Only one frame will be lost by making this check. Do not open the camera in bright light or the sensitive film may be fogged.

Spool ejector. This device simplifies spool changing.

A slight pressure on the ejector lever frees both spools, which can then easily be removed from the camera. Holding it firmly so that the film cannot unwind, place the full spool in its metal container.

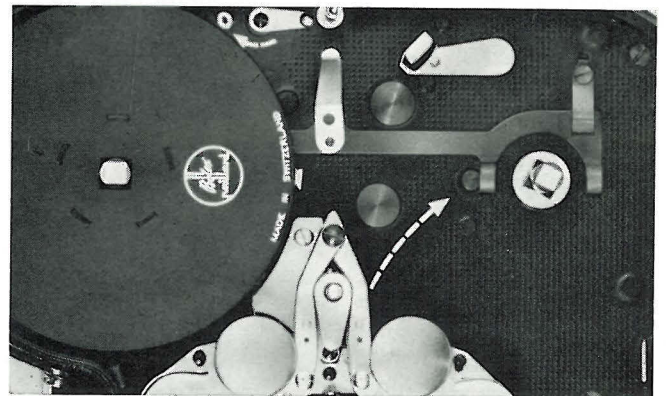
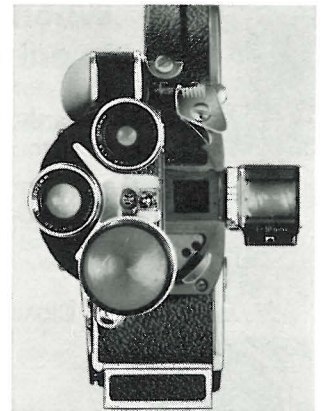
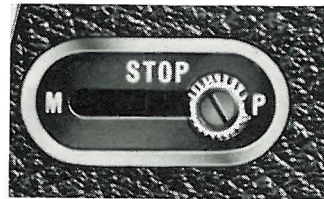
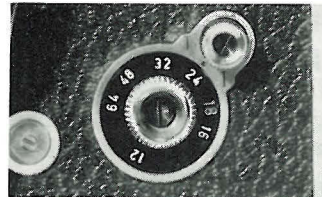



When the film is only partly exposed

A partly exposed film can be removed from the camera as follows:

1. Note the figure on the footage counter.
2. Close the variable shutter.
3. Disengage the motor and rewind the film until the sign **ft.** appears opposite the white line in the mask.
4. Open the camera lid and unload the camera in a dim light.
5. Do not forget to open the variable shutter before beginning the new film.

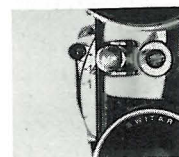
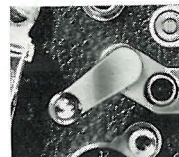
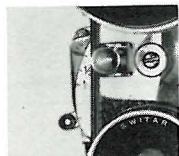

To replace a partly exposed film in the camera:

6. Load the camera as described on page 26.
7. Close the variable shutter.
8. Press the release until the footage counter reaches the figure already noted.
9. Before beginning to film, it is advisable to press the release and run the camera for a second or two, to avoid the risk of double exposure.

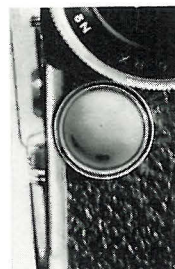
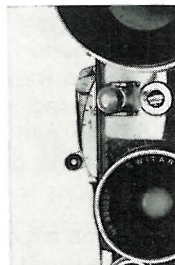

N. B. For greater accuracy, use the frame counter which enables you to recommence filming from exactly the frame where you left off.

Practical advice

Do not start filming before having thoroughly read this booklet and studying the operation and various settings of your camera. Here are several rules we suggest you follow when shooting your first films.

Camera stability

The camera should be held absolutely steady for the

slightest jerk is amplified on the screen and results in unsteady pictures.

Rest the camera against the forehead or cheek, stand with the legs wide apart and, where possible, lean against a firm support, such as a wall or tree trunk.

Move the camera slowly and smoothly. It is advisable to use a grip and, if possible, a tripod. A tripod is essential when using a zoom or telephoto lens.

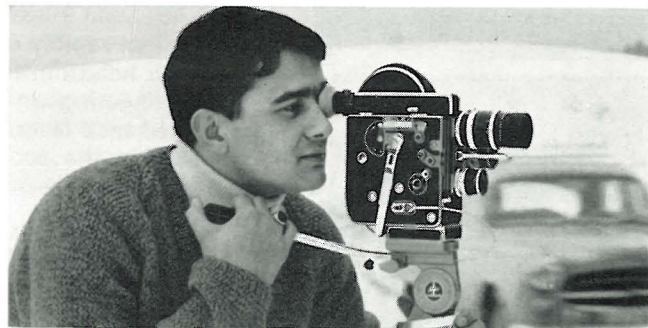



Film composition

A good film is generally composed of a smooth and coherent succession of short scenes. Depending on the subject, scenes should average between five and ten seconds. If the action to be filmed lasts longer, divide it into several shots, taken from different angles and distances (long shots, medium shots and close-ups). In this case, use a zigzag approach rather than advancing in a straight line or the resulting impression will be that the subject is leaping towards the camera.

Never film rapidly moving subjects from a right angle but from a three-quarter angle or head on. Remember that movement makes a film lively and interesting. Avoid lingering on static objects and vary the shooting angles. A zoom lens, operated by a lever, can give the impression of smoothly approaching or moving away from the subject (an optical travelling effect) or of following a moving subject (a follow-on travelling effect), but such effects should be used in moderation.

If the camera stops while you are filming, change your position before continuing with the same scene so that the interruption will be less obvious. Get into the habit of rewinding the camera after each scene, however short.

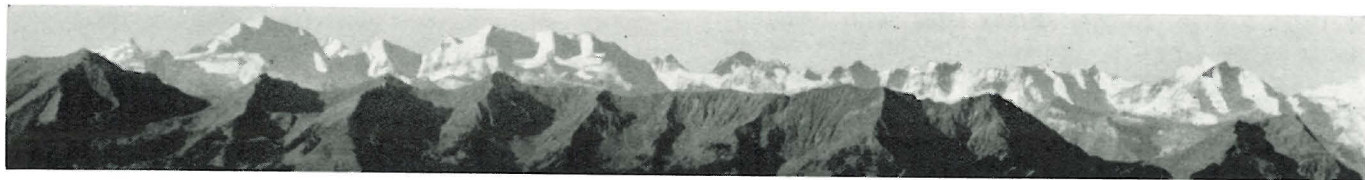

Panning shots

A panning shot is made by swivelling the camera vertically or horizontally to embrace a landscape, a building or any other extensive scene. Panning should be kept to a minimum—continual sweeps of the horizon make for very dull viewing.

Start panning with a static view of the subject, then move the camera slowly and smoothly, finishing the movement by again holding the camera steady on the subject for a second or two. Never pan back over the same subject. The longer the focal length used, the slower the movement should be. At 16 or 18 f.p.s., a movement of 45° should take at least 15 seconds with a standard 25 or 26 mm lens and 45 seconds with a 75 mm telephoto lens. More simply, allow seven seconds to move from one side to the other, or from top to bottom, of the picture seen in the viewfinder, whatever focal length is used. These times should be reduced by one third when filming at 24 f.p.s.

If no tripod is available, use a grip and rest the elbows on a firm support.

Lighting

Front or side lighting gives excellent results with colour films, back lighting can be awkward. On the other hand, backlighted subjects are easier to shoot with black-and-white film. The best times for filming are shown in the instructions leaflet accompanying each film. Fairly bright, but not overhead light is required for colour films while morning and evening are the best times for shooting with black-and-white film.

Indoor filming. Interiors can be filmed, even in daylight, with a fast lens. When the light is insufficient, artificial light must



be used. We recommend Bolex-Lites with halogen-quartz lamps, which are especially bright, light-weight and long lasting. When shooting colour sequences, use artificial light type film. For good colour reproduction, it is advisable not to mix natural and artificial light.

Night sequences. With a very fast lens, fireworks and lighted neon signs can be filmed with excellent results. Film at 12 f.p.s. if the light is not strong enough (use of tripod recommended).

Editing and titling films

After shooting several films, you will probably want to "edit" them, i.e. cut out those sequences which are lacking in interest or poor in quality, reduce the length of others and arrange the scenes in a logical and artistic order. The interest of your film will be enhanced by adding a main title and sub-titles where appropriate. It is also a good idea to show where the action took place. For this, you can make use of maps, road signs,

36 or design your own titles (see page 47).

Adding sound to films. A commentary of musical accompaniment will add to the interest and enjoyment of viewing your films.

16 mm films can take an optical or magnetic sound track. If you intend adding a magnetic sound track, make sure that the film you will use has only one row of perforations. For good sound reproduction, shoot the film at 24 f.p.s. For speech on magnetic sound stripe, a filming speed of 18 f.p.s. is satisfactory.

The Bolex S-321 sound projector enables you to record sound on films equipped with a magnetic stripe as well as to project films with either optical or magnetic sound track (see page 48).



Animation technique

Still subjects, such as articulated dolls or fluffy animals can be animated by single frame filming. After shooting one frame of the subject, move it by a fraction of an inch and take a second shot. Move the subject yet again, or slightly change its position, expose a third frame, and so on.

The speed and smoothness of a movement depends on the number of frames used to animate it. Before beginning to film, calculate the number of frames required for the available projection time. For instance, if you want a movement to last 10 seconds on the screen, when projected at 18 f.p.s., you will need to shoot 180 frames.

Single frame filming is also used for titling, for animating a route on a map, for effects such as the growth of a plant, the spontaneous blooming of flowers and comic effects, such as people moving at an unnaturally rapid pace.

For all these effects, you should use the Bolex Titler or the Bolex tripod with its platform that locks into position for maximum stability. A cable release ensures absolutely steady and unchanging framing of the subject.

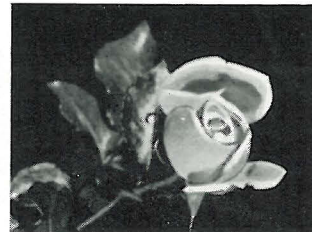
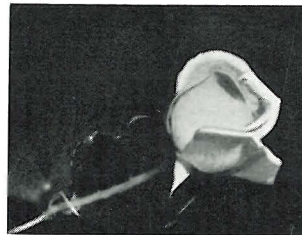
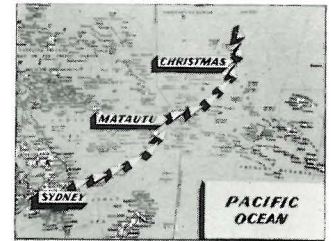
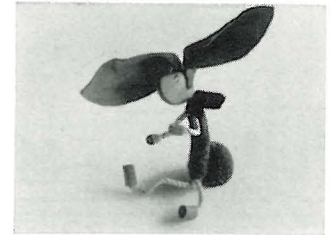

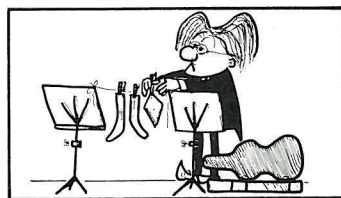
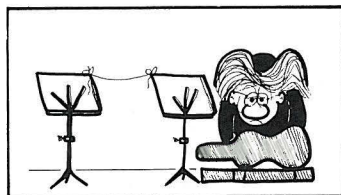
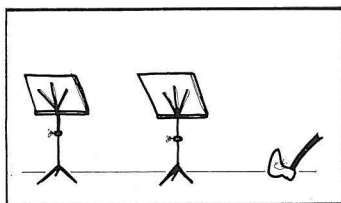

Cartoons

This technique gives full scope to your imagination but requires some artistic ability. Each movement of the subject is broken down and reproduced in a series of drawings, each showing a fractional part of the movement. These drawings are made on sheets of acetate then placed, in order, on the animation table or the Bolex Super Titler and filmed frame by frame.

Each frame must be sharply drawn. If you are making a colour film, hatch the backs of the acetate sheets to make the drawings stand out. The position of the drawings must be carefully matched by means of punched holes to ensure good continuity. The Bolex Super Titler with its adjustable guide pins ensures accurate placing and maximum camera stability while filming.

Macro- and microcinematography

Every day, scientists, businessmen, engineers—and countless amateur movie makers—use micro- and macrofilming techniques for studies and research. The movie camera has proved invaluable for recording actions and phenomena which are normally impossible to observe.

Macrofilming is the filming of minute subjects, still or moving, at very short range. This is achieved by increasing the distance between the film plane and the lens seat with extension tubes placed between the camera and the lens. Paillard-Bolex produce a set of four extension tubes (see page 45) which increase the lens seat/film plane distance from 5 mm to 75 mm. For maximum definition, the lens focusing must be adjusted with extreme accuracy. Allowing for a continuous increase in the extension of the lenses employed, the bellows attachment completes the camera's range of accessories for very close range filming. The lens gives an extension from 0 to 85 mm; it is fitted with a diaphragm preselection ring. Smooth and accurate focusing is ensured by the focusing rack on the tubular guides for the lens mount. Two scales make the bellows attachment very simple to use and obviate the need for tables. Here again, the reflex viewing system will ensure perfect framing and distance setting.

Microcinematography consists of filming with the aid of a microscope and is principally used to record various chemical and biological processes.

The illustration opposite shows the unit developed by Wild S.A. of Heerbrugg, Switzerland.

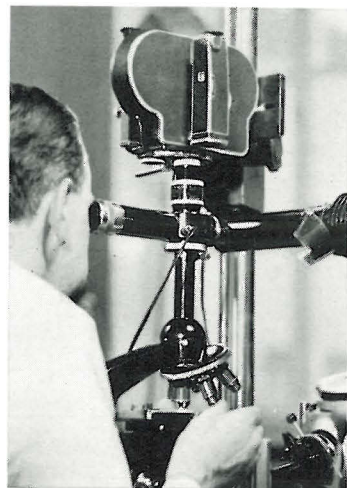
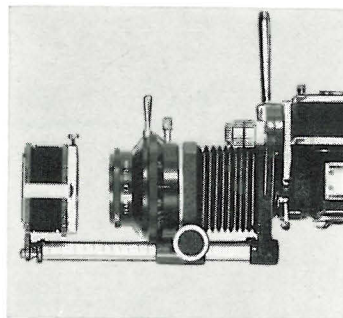

Faulty films and their possible causes

Film all black

Variable shutter left closed.

**Film under-exposed, pictures reversed,
general orange tint**

Film incorrectly loaded with dark side facing towards the lens.

Pictures too dark and flat

Under-exposure (too small a diaphragm opening for the filming speed, film sensitivity and shutter aperture).

Pictures too clear and washed-out

Over-exposure (too wide a diaphragm opening for the filming speed, film sensitivity and shutter aperture).

Blurred pictures

Inaccurate distance setting.

"Jumpy" pictures

Camera unsteadiness or panning too rapidly.

Unnatural colouring

Using filters designed for black-and-white film when shooting in colour.

Too long a delay between exposure and development.
Films poorly stored before or after exposure.

Dominant red-orange tint

Filming too early in the morning or too late in the evening.

Using tungsten lamps with a daylight type film or an under-powered lamp with "artificial light" film.

Dominant blue tint

Filming distant subjects at high altitudes or on water without the appropriate filter. Water scenes with strong reflections, filmed without polarizing filter.

Partly obscured pictures

An object, such as a finger or a long telephoto lens, in front of the taking lens.
Turret badly positioned.

Parallel scratches on the edge of the film

Dust or particles of emulsion in the film gate.
Camera badly loaded.

Fogged film

Direct light entering through the reflex viewfinder.

Film fogged at edges

Careless loading or unloading of the camera so that sensitive film was accidentally exposed to light. The filter-mount left out of its slot.

Out-of-focus or distorted picture

Pressure pad incorrectly locked.

Carefully following the instructions in this booklet, you will help to avoid the above mistakes and produce excellent films.

How to look after your camera

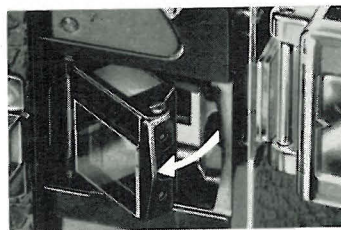
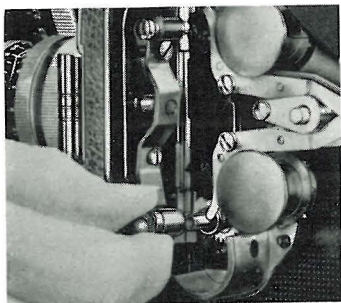

The interior of the camera, housing the film drive mechanism, must be kept spotless.

Gelatine deposits and dust sometimes accumulate in the gate and on the pressure pad when unexposed film is run through the camera and should be removed as follows:

- a) Open the pressure pad by lifting its pin.
- b) Unscrew the shaft and remove the pressure pad by pulling it towards you.
- c) Gently clean the gate and pressure pad, paying special attention to the aperture, using a clean cloth wound round the end of a small stick. If the gelatine deposit is hard to remove, damp the cloth and thoroughly dry the part after cleaning.
- d) Replace the pressure pad.

Reflex prism. The reflex prism in front of the aperture can be reached by turning the turret. As it is mounted on hinges, it can be swung out for cleaning the back and the ground glass. Use a soft, dry brush or special paper for cleaning these parts. The prism can be cleaned even when the camera is loaded (preferably in the shade).

Important! The reflex viewfinder must not be dismantled.

Lenses. Keep the outer surfaces of your lenses absolutely clean with the special soft tissue paper sold in photographic shops. Avoid rubbing the lens more than necessary as this could damage the anti-reflection coating. Screw on the lens caps between takes. Special care should be taken to avoid dust or fingerprints (perspiration attacks glass).

Special care of the camera in tropical regions. Various precautions should be taken to protect both camera and film against heat and humidity.

Airtight boxes are available to store films in the tropics. Never leave film in the camera longer than the time necessary to expose it.

The camera and all accessories should be cleaned regularly and thoroughly. Leather and the carrying cases should be treated with special product available from leather merchants.

To prevent hot, moist air from condensing and aiding the formation of bacterial growths, do not place your equipment in its cases between takes, but leave it freely exposed to the air.

However, for storing your equipment, especially during the monsoon season, use airtight tin boxes with a silica gel or calcium chloride humidity absorber. Avoid using these chemicals too liberally, however, to prevent excessive drying, which might damage leather and film. A relative humidity of 35 to 40 % is satisfactory. Care should be taken to prevent any of the chemical coming into contact with your equipment.



Precautions against cold and sand. If you are going to film at high altitudes or in very cold climates, send your camera to the Paillard-Bolex agent for special greasing and winterizing.

Guard against getting sand or dust in your camera, which could scratch or damage its mechanism. Where necessary, put the camera in its case between each take and, for extra protection, put the case in a plastic bag.

To complete your equipment



Three top quality zoom lenses ensure excellent sharpness and definition at all focal lengths.

SOM-Berthiot Pan-Cinor 85 (17-85 mm f/2). A lens outstanding for its large aperture. A reflex viewfinder with coincident image rangefinder affords easy and extremely accurate focusing.

Kern-Paillard TTL Vario-Switar 86 E (18-86 mm f/2.5). This lens with automatic diaphragm control is designed exclusively for H 16 Reflex cameras. One lever starts the camera running and varies the focal length.

Zoom Angenieux 12-120 (12-120 mm f/2.2). With its exceptional range of focal lengths, this lens could replace a complete set of fixed focal length lenses. As well as a lever, a small crank handle is provided for achieving absolutely smooth zoom effects. (Not available from the Paillard-Bolex distributor in some countries.)

Macro-Yvar 150 mm f/3.3 and Macro-Yvar 100 mm f/2.8. These two telephoto lenses are equally suitable for filming subjects close at hand or at a considerable distance away. A dual-range extension affords exceptionally wide focusing range.

Extension tubes. Used in macrocinematography to achieve magnification of minute subjects, such as insects, filmed at very short range. The reflex viewing system of the H 16 Reflex camera permits highly accurate framing and distance setting. The tubes are supplied with a calculator table.

REX-Fader. Automatically and smoothly opens and closes the variable shutter, thus permitting professional quality fades and lap dissolves.

Electric motors. See page 18.

Automatic selftimer. This accessory enables the operator to get into the picture himself by starting the camera running six seconds after the timing mechanism has been set and allowing for a predetermined shooting time of between 5 and 20 seconds.

Cable releases. Recommended for normal or single frame filming when absolute steadiness is required. Two lengths available: 21" and 40".

Bolex lightmeter. It is always advisable to use an exposure meter, particularly when filming in colour. The Bolex lightmeter is designed for motion filming and especially calibrated for use with the H 16 Reflex camera.

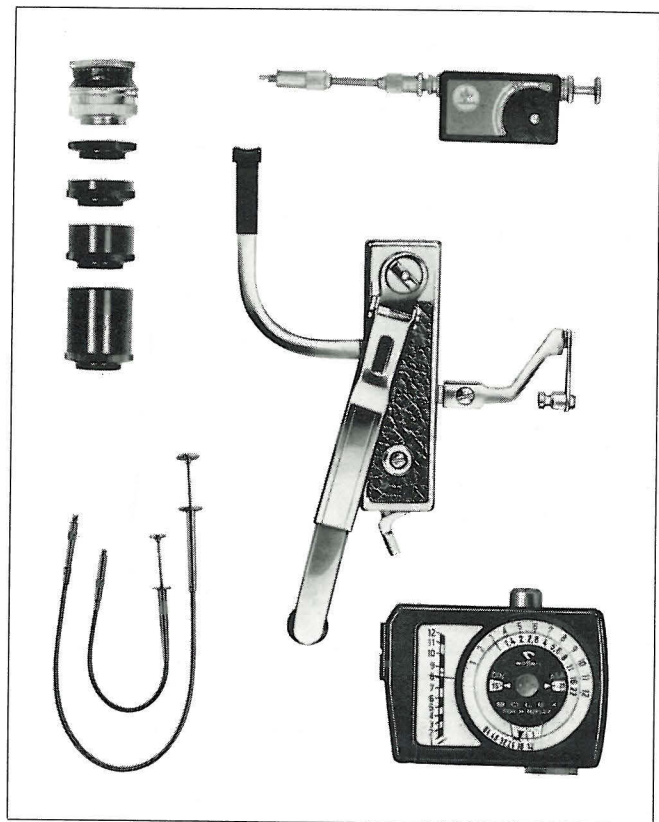

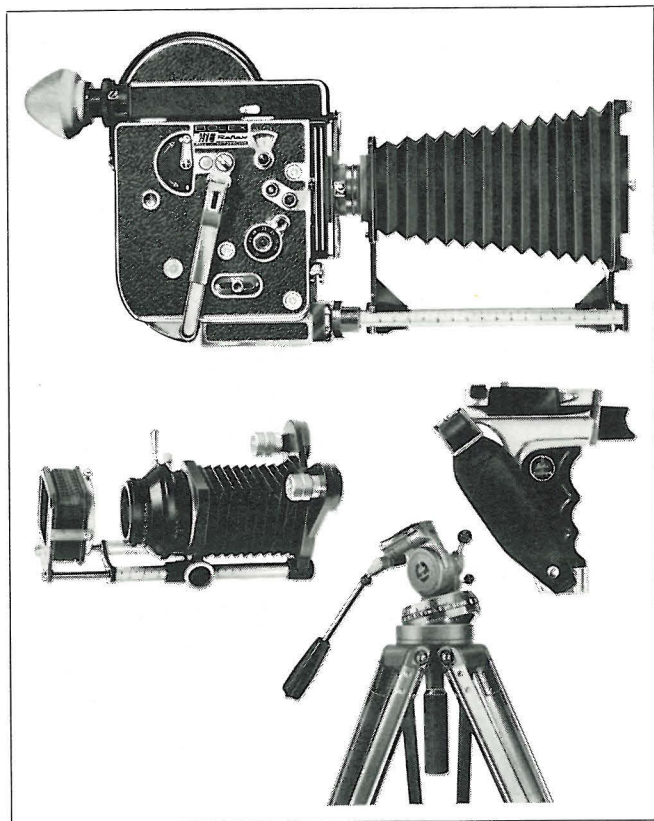

Bolex matte box. Acts as a highly efficient lens hood and can also be used as a portable accessory for titling and trick effects, such as entering a room through the keyhole, making the same character appear several times on the same picture, framing a landscape in binoculars, etc.

Bellows attachment for macrofilming. For filming at very close range, focusing is simplified by the geared guide plate which allows for continuous increase in the lens focal length. Two reduction adapter rings make it possible to fit other lenses.

Hand grip. Gives a good firm grip on the camera, thereby increasing camera stability. Quickly mounted on the camera by its fixing device.

Electric H grip. Similarly designed, can be used for releasing the different electric motors.

Bolex tripod. A tripod ensures picture steadiness and is essential when using lenses with focal lengths over 50 mm. The Bolex tripod, especially designed for your

camera is strong, very easily adjusted and quickly fitted up.

The Bolex swivel-joint complements the tripod by enabling rapid camera levelling, a great advantage when filming on uneven ground.

Underwater housing. Enables the diver to film down to a depth of 300 ft. Absolutely watertight, highly stable and very simple to handle under water. The camera is quickly removed and fitted into the housing without tools.

Bolex super titler. A high-precision instrument, light yet robust, enabling you to produce a wide variety of titles, as well as special and trick effects, with excellent results.

Carrying cases. Several models available in good quality leather and in aluminium.

In preparation. A special electric motor is now being designed for single frame filming, for use with or without an automatic timing device.

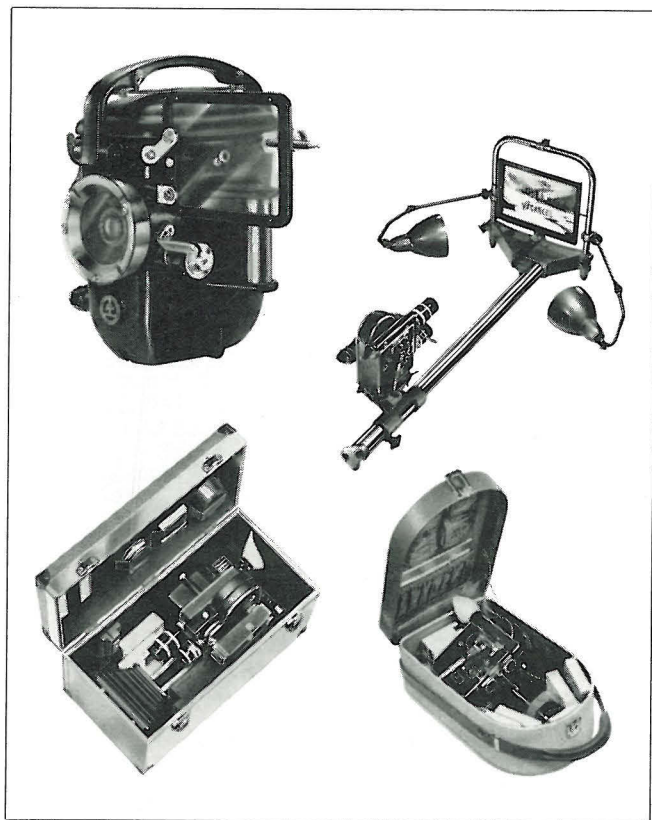

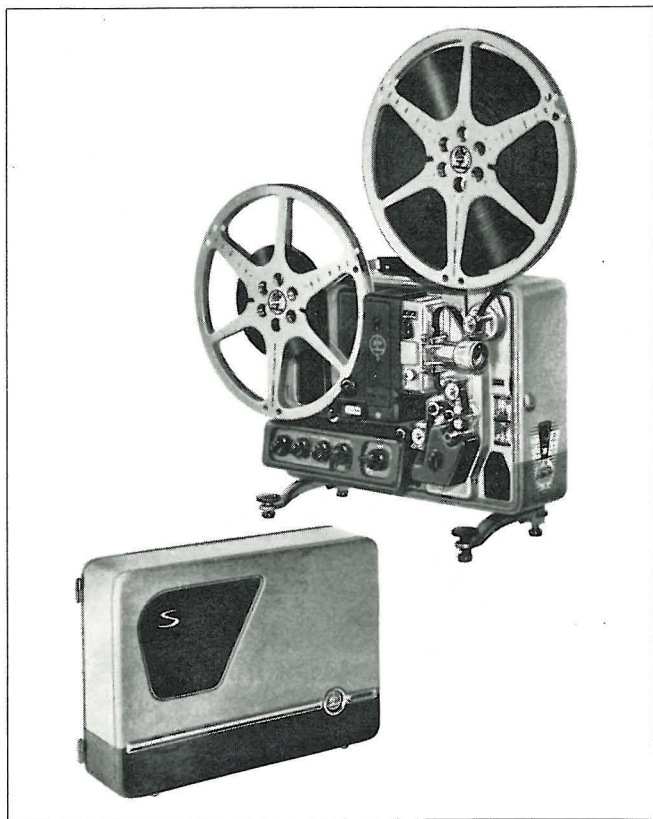

Bolex S-321 sound projector. This projector is engineered with the same high precision as your camera. It makes the perfect partner for the H 16 Reflex and does full justice to your sound and silent films. Furthermore, it ensures complete film protection and permits recording of sound on films with magnetic stripe.

Frequency range:

Magnetic sound: 50 to 10,000 cycles/sec. \pm 3 decibels

Optical sound: 50 to 7,000 cycles/sec. \pm 3 decibels

Bolex S-311 sound projector. Has the same features as the S-321, but is designed uniquely for projecting optical sound films.

Amplifier:

Frequency range: 30 to 16,000 cycles/sec. \pm 3 decibels

Power output: 15 W

Loudspeaker:

Built into the projector lid, power output: 6 W

Auxiliary (available as accessory), power output: 20 W

"Hi-Fi" lens:

3 focal lengths available: 35 mm f/1.3 — 50 mm f/1.3

— 70 mm f/1.6

Index

Accelerated motion	16	Filters	14	Perforations	7
Accessories	44	Filter holder	14	Picture sharpness	25
Additional lenses	9	Focusing	12	Pressure pad	27
Animation	37	Fogging	26	Reflex prism	8
Audible signal	30	Footage counter	29	Reflex viewfinder	8
Auxiliary viewfinder	9	Footage counter pin	29	Releases	17
Cable releases	45	Greasing	43	Rewind handle	16
Carrying case	47	Grip	46	REX-Fader	45
Cartoons	38	Guarantee	1	Serial number	1
Closing the viewfinder	9	Hand crank	19	Single frame filming	17
Cold	43	Heat	43	Slow motion	16
Control lever for instantaneous or time exposures	17	Humidity	43	Sound recording	36
Control lever for loop formers	27	Lens cap	42	Speeds	16
Control lever for variable shutter	20	Lenses	44	Spool ejector	31
Depth-of-field	12	Lens seat/film plane distances	12	Sprockets	27
Diaphragm	13	Lid	27	Stability	33
Disengaging motor	19	Lighting	35	Table of exposure times	13
Distances	12	Lightmeter	13	Telephoto lenses	11
Double exposures	23	Loading	27	Titler	47
Editing films	36	Locking ring	27	Titling	36
Exposure table	13	Loop formers	27	Travelling effects	34
Extension tubes	45	Macro- and microcinematography	39	Trick effects	37
Fades	21	Maintenance	42	Tripod	46
Faults (on film)	40	Motor disengaging lever	19	Turret	11
Field adapter	9	Motor reserve	16	Turret lever	11
Film adapter	27	Motors	18	Underwater housing	47
Film leaders	7	Optical and magnetic sound tracks	36	Unloading	31
Film plane	12	Pan-Cinor lenses	44	Variable shutter	20
Film retaining arm	5	Panning shots	35	Viewfinder eyepiece	8
Films	7	Parallax correction of auxiliary viewfinder	10	Wide-angle lens	11
Film sensitivities	13				

PAILLARD S.A. SAINTE-CROIX (Switzerland)

ME 111/96 Anglais Printed in Switzerland

